



Install the future!

Magic PV Solution:
Innovative mounting systems for photovoltaic systems



This is how safe solar can be!

With a photovoltaic system, continuous availability is of decisive significance. With OBO, you are always on the (b)right side: This is because we not only offer you a complete system for almost every electrical requirement of a photovoltaic system, but also future-oriented solutions for flexible installations. Leading the way are our innovative mounting systems for pitched roofs, flat roofs and free-standing systems: the Magic PV solution. For more efficiency from A to solar!



The benefits of the Magic PV solution

- Less work: A slim overall portfolio offers a simplified product selection and reduces warehouse storage to a minimum.
- More flexibility: With the Magic PV solution, countless customer-specific solutions and structural implementation options can be implemented.
- More security: Correct installation of all standard PV module dimensions is very simple.
- Versatile: The OBO systems can be adapted to different installation conditions with ease.
- More future: Digital planning tools and an innovative product configurator provide support in advising your customers.





Mounting system for Pitched roof systems

Most pitched roof systems are mounted on existing building roofs as so-called on-roof systems. Here, the PV modules are attached to the roof rafters using roof hooks, mounting rails and module clamps made of metal.



- Magic technology: Enables the profiles to be installed without screws or tools, thus saving time.
- Roof hook solution: Can be mounted on all standard pitched roof types and adjusted infinitely and down to the millimetre in all directions at any time.
- Universal clamp: Simultaneously functions as an intermediate or end clamp, covering a clamping range of 30–50 mm. For easy fixing of all standard PV modules.

Fewer components, less work.

The products for flat and pitched roof systems can be combined. This considerably reduces the number of individual components required.





Mounting system for flat roof systems

Photovoltaic systems can also be placed on flat roofs. The advantage here is that the PV modules can be mounted independently of a specific roof orientation.



- Magic technology: Enables the profiles to be installed without screws or tools, thus saving time.
- UniBase ballast system: For variable weighing down of the overall system using rectangular blocks – even at any time after installation!
- Can also be combined with other OBO products, as required, e.g. with the adapter for mesh cable trays, type 165 MBG HGRM.
- Universal clamp: Simultaneously functions as an intermediate or end clamp, covering a clamping range of 30–50 mm. For easy fixing of all standard PV modules.



Mounting system for Free-standing systems

Free-standing photovoltaics means the erection of PV modules on large areas not used for agriculture. Under favourable conditions, these photovoltaic systems can produce increased yields.



- The highest level of flexibility: Both rammed and anchored versions are available.
- Little installation work: We can offer you system components pre-mounted at the factory.
- Maximum mounting options: The profile with flexible length and perforation allows almost type of mounting. Besides the intended OBO terminals, also using standard fastening materials, such as standard bolts.

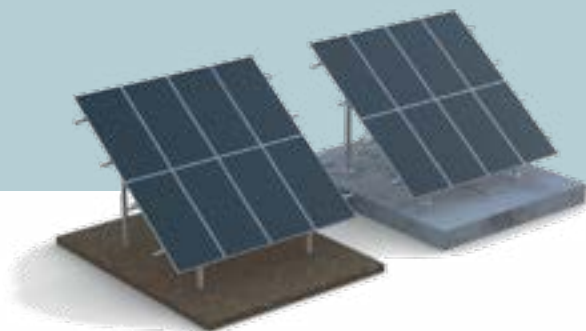

A2 2B

Universal roof hook for PV module mounting, tiled roof



Type	Length mm	Pack Piece	Item no.
DHU A2		10	5901410

Roof hook to mount photovoltaic modules on pitched roofs in combination with the TP 45 support profile. Suitable for tiled roofs. Lockable fastening on support profile. Mounting on rafters with TKS wafer-head screws. Roof hook can be infinitely adjusted horizontally and vertically using glands, correct spanner Torx 40. Height adjustment in the range of the roof slat between 40–54 mm, side adjustment option up to 76 mm, height adjustment of the support profile up to 18 mm.

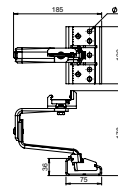

A2



Wafer-head screw for roof hooks

Type	Length mm	Pack Piece	Item no.
TKS 8x100 A2	100	100	5901800
TKS 8x120 A2	120	100	5901802
TKS 8x200 A2	200	50	5901804

Wafer-head screw for fastening roof hooks to rafters when mounting photovoltaic modules on pitched roofs. Matching Torx 40 key.

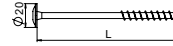

Alu BK



Support profile for PV module mounting

Type	Length mm	Pack Piece	Item no.
TP 45 4700 ALU	4700	4	5900410
TP 45 2350 ALU	2350	4	5900405

Support profile to mount photovoltaic modules on flat and pitched roofs. Flat roof mounting in combination with UniBase universal stand and STK and STL short and long supports. Lockable fastening of the profile on the stand with UniBase AMP adapter. Pitched roof mounting in combination with universal DHU roof hook. Lockable fastening of the profile on roof hooks. Screwable connection of multiple support profiles with LV 45 straight connectors and KV 45 cross-connectors. With 10 mm groove on both sides to accept slide nuts and universal and earthing clamps.

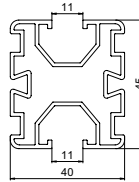

Alu EL

Support profile for PV module mounting

Type	Length mm	Pack Piece	Item no.
TP 45 4700 ALU S	4700	4	5900412

Support profile, black anodised, to mount photovoltaic modules on flat and pitched roofs. Flat roof mounting in combination with UniBase universal stand and STK and STL short and long supports. Lockable fastening of the profile on the stand with UniBase AMP adapter. Pitched roof mounting in combination with universal DHU roof hook. Lockable fastening of the profile on roof hooks. Screwable connection of multiple support profiles with LV 45 straight connectors and KV 45 cross-connectors. With 10 mm groove on both sides to accept slide nuts and universal and earthing clamps.

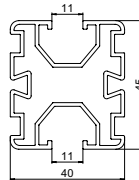

Straight connector for TP support profile

St DD
CE

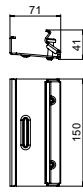

Type	Colour	Pack Piece	Item no.
LV 45 DD		20	5901210

Straight connector for TP support profiles. Can be screwed on with Torx 30 spanner.

Cross-connector for TP support profiles

St DD
CE

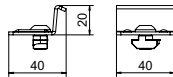
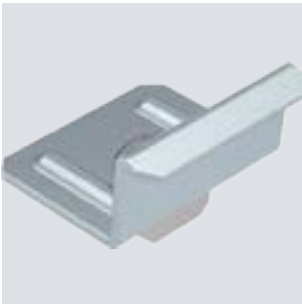

Type	Colour	Pack Piece	Item no.
KV 45 DD		20	5901250

Cross-connector for TP support profiles. Can be screwed on with Torx 40 spanner.

Support profile end cap

PE
CE

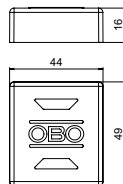

Type	Colour	Pack Piece	Item no.
EK 45 G	Grey	20	5901722
EK 45 S	Black	20	5901720

End cap for TP support profiles, as protection against injuries and contamination.

Bolt with hammer nut for PV module mounting

A2
CE

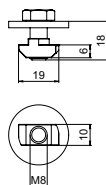
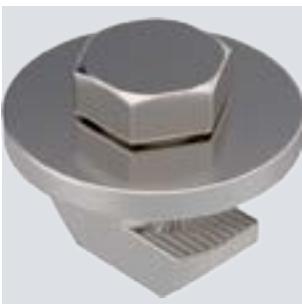

Type	Thread	Pack Piece	Item no.
SKS HM A2	M8	20	5901850

Bolt with hammer nut to fasten metal roof plates of make Lehmann to TP 45 support profiles.

A2

Earthing terminal for PV mounting systems

Type	Fit mm	Lightning current carrying capacity kA	Pack Piece	Item no.
249 PV10 6-50V2A	RD8-10 + 6-50mm ²	H/100	8	5051520

Pre-mounted earthing terminal for the inclusion of PV mounting systems in the equipotential bonding. Suitable for the inclusion of the PV mounting systems in an external lightning protection system.

- Lightning current-compatible up to 100 kA (10/350)
- Rapid mounting through integrated spring mechanism
- For round conductor fastening RD 8–10
- To fasten single/multi-wire cables: 6–50 mm²
- For profiles with 10 mm groove
- Meets the requirements of DIN EN 62561-1

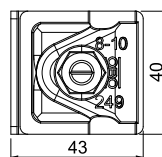
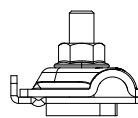

A2 BK

Universal clamp for PV module mounting



Type	For frame height mm	Pack Piece	Item no.
KLU A2	30-50	20	5901010

Universal clamp to mount photovoltaic modules on flat and pitched roofs, suitable as a clamp between 2 modules or as an end clamp. Lockable pre-fastening on TP 45 support profile and on STK and STL supports. Suitable for 10 mm slot width. Can be rotated through 90° after engaging. Lockable fastening of the PV module with Torx 30 wrench.

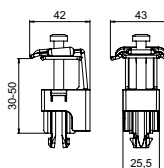

A2 K

Universal clamp for PV module mounting



Type	For frame height mm	Pack Piece	Item no.
KLU A2 S	30-50	20	5901012

Universal clamp to mount photovoltaic modules on flat and pitched roofs, suitable as a clamp between 2 modules or as an end clamp. Lockable pre-fastening on TP 45 support profile and on STK and STL supports. Suitable for 10 mm slot width. Can be rotated through 90° after engaging. Lockable fastening of the PV module with Torx 30 wrench.

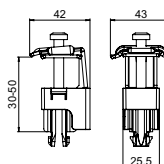

UniBase universal stand

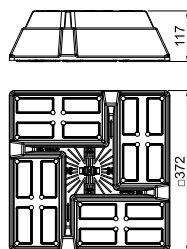

Type	Length mm	Width mm	Height mm	Pack Piece	Item no.
UniBase 10	372	372	117	8	5403393

Universal stand for ballasting with standard blocks up to a dimension of 200 x 100 x 100 mm. Can be used on flat roofs, e.g. for mounting PV mounting systems or for cable routing with cable trays or with mesh cable trays in conjunction with roof cable holder 165 MBG HGRM. Blocks not contained in the scope of delivery.

Adapter for TP 45 support profile

ASA

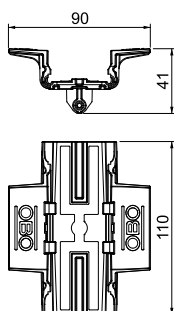

Type	Pack Piece	Item no.
UniBase TMP	16	5403397

Adapter for TP 45 support profile, for mounting on UniBase universal stand. Toolless mounting through snapping. With side holes for optional screwing. Toolless mounting and dismantling of the support profile possible. With non-slip support surface.

Support profile for PV module mounting

Alu BK EL

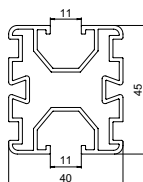

Type	Length mm	Pack Piece	Item no.
TP 45 4700 ALU	4700	4	5900410
TP 45 2350 ALU	2350	4	5900405
TP 45 4700 ALU S	4700	4	5900412

Support profile to mount photovoltaic modules on flat and pitched roofs. Flat roof mounting in combination with UniBase universal stand and STK and STL short and long supports. Lockable fastening of the profile on the stand with UniBase AMP adapter. Pitched roof mounting in combination with universal DHU roof hook. Lockable fastening of the profile on roof hooks. Screwable connection of multiple support profiles with LV 45 straight connectors and KV 45 cross-connectors. With 10 mm groove on both sides to accept slide nuts and universal and earthing clamps.

Support profile for PV module mounting

Alu EL

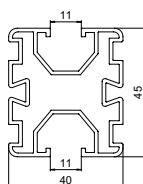

Type	Length mm	Pack Piece	Item no.
TP 45 4700 ALU S	4700	4	5900412

Support profile, black anodised, to mount photovoltaic modules on flat and pitched roofs. Flat roof mounting in combination with UniBase universal stand and STK and STL short and long supports. Lockable fastening of the profile on the stand with UniBase AMP adapter. Pitched roof mounting in combination with universal DHU roof hook. Lockable fastening of the profile on roof hooks. Screwable connection of multiple support profiles with LV 45 straight connectors and KV 45 cross-connectors. With 10 mm groove on both sides to accept slide nuts and universal and earthing clamps.

St DD



Straight connector for TP support profile

Type	Pack Piece	Item no.
LV 45 DD	20	5901210

Straight connector for TP support profiles. Can be screwed on with Torx 30 spanner.

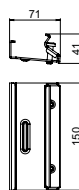

St DD



Cross-connector for TP support profiles

Type	Pack Piece	Item no.
KV 45 DD	20	5901250

Cross-connector for TP support profiles. Can be screwed on with Torx 40 spanner.

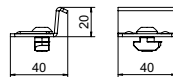

PE



Support profile end cap

Type	Colour	Pack Piece	Item no.
EK 45 G	Grey	20	5901722
EK 45 S	Black	20	5901720

End cap for TP support profiles, as protection against injuries and contamination.



St DD



Short support for PV module mounting, flat roof

Type	Pack Piece	Item no.
STK DD	8	5901650

Short support to mount photovoltaic modules on flat roofs in combination with the TP 45/4700 support profile and KLU universal clamp. Slope angle 15°. Lockable fastening on support profile.

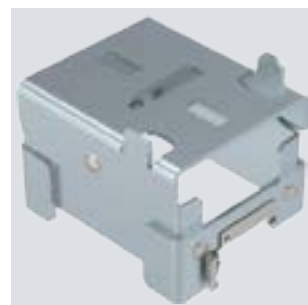
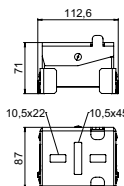

Long support for PV module mounting, flat roof

St DD

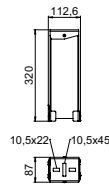

Type	Length mm	Pack Piece	Item no.
STL 15 DD		4	5901655

Long support to mount photovoltaic modules on flat roofs in combination with the TP 45/4700 support profile and KLU universal clamp. Slope angle 15°. Lockable fastening on support profile.

Wind protection panel for photovoltaic systems

St DD

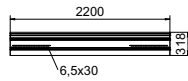

Type	Length mm	Pack Piece	Item no.
WSB 2200 DD	2200	4	5901610

Wind protection panel for use with photovoltaic systems with south alignment and standard inclinations of 15°. As protection against wind loads during extreme wind conditions. Lockable and screwable fastening to STL 15 long support.

Flat-head screw for wind protection plate

A2 2B



Type	Dimension mm	Pack Piece	Item no.
FKS M6x25 A2	M6x25	100	5901880

Flat-head screw with hexalobular internal to fasten wind protection plates to the STL 15 long support of the photovoltaic mounting systems for flat roofs. Matching Torx 30 key.

Universal clamp for PV module mounting

A2 BK

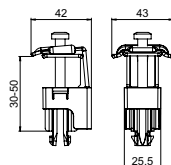

Type	For frame height mm	Pack Piece	Item no.
KLU A2	30-50	20	5901010

Universal clamp to mount photovoltaic modules on flat and pitched roofs, suitable as a clamp between 2 modules or as an end clamp. Lockable pre-fastening on TP 45 support profile and on STK and STL supports. Suitable for 10 mm slot width. Can be rotated through 90° after engaging. Lockable fastening of the PV module with Torx 30 wrench.

A2 K

Universal clamp for PV module mounting



Type	For frame height		Pack Piece	Item no.
	mm			
KLU A2 S	30-50		20	5901012

Universal clamp to mount photovoltaic modules on flat and pitched roofs, suitable as a clamp between 2 modules or as an end clamp. Lockable pre-fastening on TP 45 support profile and on STK and STL supports. Suitable for 10 mm slot width. Can be rotated through 90° after engaging. Lockable fastening of the PV module with Torx 30 wrench.

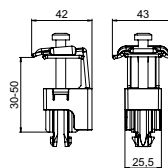

A2

Earthing terminal for PV mounting systems

Type	Fit mm	Lightning current carrying capacity kA	Pack Piece	Item no.
249 PV10 6-50V2A	RD8-10 + 6-50mm ²	H/100	8	5051520

Pre-mounted earthing terminal for the inclusion of PV mounting systems in the equipotential bonding. Suitable for the inclusion of the PV mounting systems in an external lightning protection system.

- Lightning current-compatible up to 100 kA (10/350)
- Rapid mounting through integrated spring mechanism
- For round conductor fastening RD 8–10
- To fasten single/multi-wire cables: 6–50 mm²
- For profiles with 10 mm groove
- Meets the requirements of DIN EN 62561-1

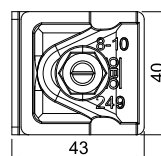
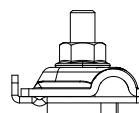

St FT

Mesh cable tray GR-Magic® 55



Type	Wire		Pack m	Item no.
	Width mm	Ø mm		
GRM 55 50 FT	50	3.9	3	6001415
GRM 55 100 FT	100	3.9	3	6001416
GRM 55 150 FT	150	3.9	3	6001418
GRM 55 200 FT	200	3.9	3	6001420
GRM 55 200 4.8FT	200	4.8	3	6001421
GRM 55 300 FT	300	4.8	3	6001424
GRM 55 400 FT	400	4.8	3	6001428
GRM 55 500 FT	500	4.8	3	6001432
GRM 55 600 FT	600	4.8	3	6001436

Mesh cable tray with shaped connector of side height 55 mm.

Magnetic shield insulation without cover 15 dB, with cover 25 dB.

You can find detailed information regarding the UL classification in the respective certification.

No additional connection components are required for the mesh cable tray, it is simply interlocked. The grid width is 50 x 100 mm (exception: GRM 55/50 = 20 x 100 mm).

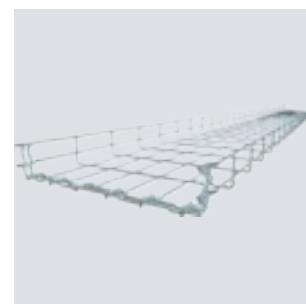
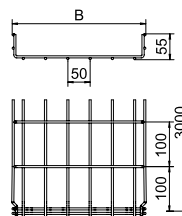

Cover for mesh cable tray, latchable

St FT

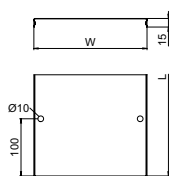

Type	Dim. B mm	Metal thickness mm	Length mm	Pack m	Item no.
DGRR 50 FT	50	0.75	3000	3	6001820
DGRR 100 FT	98	0.75	3000	3	6001822
DGRR 150 FT	148	0.75	3000	3	6001824
DGRR 200 FT	198	0.75	3000	3	6001826
DGRR 300 FT	298	0.75	3000	3	6001828
DGRR 400 FT	398	0.75	3000	3	6001830
DGRR 500 FT	498	0.75	3000	3	6001832
DGRR 600 FT	598	0.75	3000	3	6001834

With transverse bead from 400 mm width.

Lockable cover for mesh cable trays of type GR and GRM. Protects cables from damage, contamination and moisture from above. Suitable for industrial areas such as mechanical engineering.

When using covers outdoors, additional measures against the influence of wind may need to be taken.

Cable tray RKS-Magic® 60

St FT

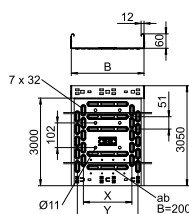

Type	Width mm	Metal thickness mm	BS	Pack m	Item no.
RKSM 610 FT	100	1.00	🔥	3	6047612
RKSM 615 FT	150	1.00		3	6047631
RKSM 620 FT	200	1.00	🔥	3	6047639
RKSM 630 FT	300	1.00	🔥	3	6047655
RKSM 640 FT	400	1.00	🔥	3	6047690
RKSM 650 FT	500	1.00		3	6047720
RKSM 660 FT	600	1.00		3	6047736

Cable tray with integrated quick fastening system. The usable length of the cable tray is 3,000 mm.

The cable tray has continuous side perforations of 7 x 20 mm for the installation of additional connection and mounting components.

The perforation for direct threaded rod suspension has a diameter of 11 mm.

Unperforated cover

St DD

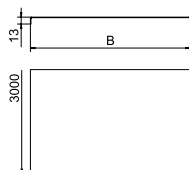

Type	Dim. B mm	Metal thickness mm	Length mm	Pack m	Item no.
DRLU 100 DD	100	1.00	3000	3	6052643
DRLU 150 DD	150	1.00	3000	3	6052647
DRLU 200 DD	200	1.00	3000	3	6052650
DRLU 300 DD	300	1.00	3000	3	6052656
DRLU 400 DD	400	1.00	3000	3	6052662
DRLU 500 DD	500	1.50	3000	3	6052668
DRLU 600 DD	600	1.50	3000	3	6052674

Cover for cable trays and mesh cable trays.

When using covers outdoors, additional measures against the influence of wind must be taken.

Transverse bead from 500 mm width.

A2 2B



Cover clamp

Type	DK DRLU A2	Pack	Item no.
		Piece	

Cover clamp for secure fastening of covers on cable trays and cable ladders.
At least 6 cover clamps should be mounted for each 3 metres of cover.

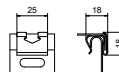

A2 K

SBR 8 tightening strap

Type	Avg. breaking load kN	Colour	Dim. B mm	Dim. t mm	Dimen-sion B1 mm	Pack m	Item no.
SBR 8 A2K	1.16	Jet black	9.3	1	8	40	6490192
SBR 15 A2K	4.19	Jet black	17	1.2	15	25	6490282

Tightening strap made of rustproof steel with plastic jacketing to fasten cables on cable support systems.

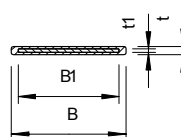

A2 2B

SBV 8 tightening strap lock

Type	SBV 8 A2	Pack	Item no.
		Piece	

Tightening strap lock made of rustproof steel, suitable for portfolio with 8 mm width.

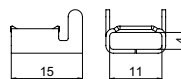

A2 2B

SBV 15 tightening strap lock

Type	SBV 15 A2	Pack	Item no.
		Piece	

Tightening strap lock made of rustproof steel, suitable for a range of products with a 15 mm width.

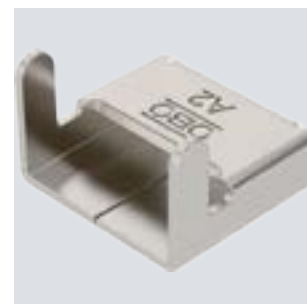
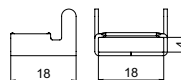

Metal strip clips, wide



Type	Length mm	Width mm	Pack Piece	Item no.
MBS 075	750	12	25	7203108
MBS 100	1000	12	25	7203110
MBS 120	1200	12	25	7203112
MBS 150	1500	12	25	7203114

Metal strip clip in ladder form with single lock. For high-temperature and weatherproof fixing. Use MBS-Z pliers to tighten.

Metal strip clips, narrow



Type	Length mm	Width mm	Pack Piece	Item no.
MBS 015	150	7	100	7203100
MBS 030	300	7	100	7203102
MBS 045	450	7	50	7203104
MBS 061	610	7	50	7203106

Metal strip clip in ladder form with single lock. For high-temperature and weatherproof fixing. Use MBS-Z pliers to tighten.

Spring chuck

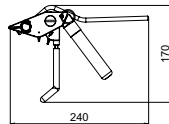

Type	Pack Piece	Item no.
576	1	6498027

Clamping tool for all OBO tightening straps in conjunction with appropriate tightening strap locks. With high clamping force, ratchet function, shortening unit and round grips for pleasant handling.

Pliers for metal strip clips



Type	Pack Piece	Item no.
MBS-Z	1	7203120

High-quality spring chuck with cutting tool for metal strip clips, type MBS.

UniBase universal stand

Type	Length mm	Width mm	Height mm	Pack Piece	Item no.
UniBase 6	372	372	78	16	5403391

Universal stand for ballasting with standard blocks up to a dimension of 200 x 100 x 100 mm. Can be used on flat roofs, e.g. for mounting PV mounting systems or for cable routing with cable trays or with mesh cable trays in conjunction with roof cable holder 165 MBG HGRM. Blocks not contained in the scope of delivery.

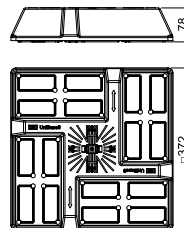

Building protection mat, flat roof

Type	Length mm	Width mm	Height mm	Pack Piece	Item no.
UniBase BSM	410	410	6	16	5403402
UniBase BSM ALU	410	410	6	16	5403404

Building protection mat as an underlay under stands of type UniBase 6 + UniBase 10 for flat roof PV mounting systems, as protection of the roof seal on flat roofs according to DIN 18531. Also suitable for height compensation of the PV mounting system. Made of recycled material; depending on the version, also available with aluminium lining.

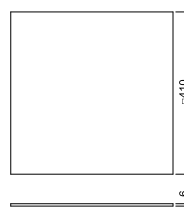

ASA

Type	Dia- meter mm	Pack Piece	Item no.
UniBase Glue	314	16	5403395

Universal stand for gluing on flat roofs. Can be used for routing cables with cable trays or mesh cable trays in conjunction with 165 MBG HGRM roof conductor holders. Gluing collar must be selected according to the substrate.

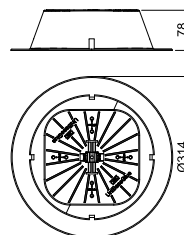

UniBase universal stand for gluing

PP

Mesh cable tray adapter for roof conductor holder

Type	Colour	Fit mm	Pack Piece	Item no.
165 MBG HGRM	Black	Rd 8	50	5218886

- Adapter for GR-Magic® mesh cable trays with a mesh width of 50 mm or 20 mm
- For fastening to type 165 MBG 8-10 and UniBase
- Mounting without tools
- From polypropylene, black, UV-resistant and weatherproof
- Toolless installation

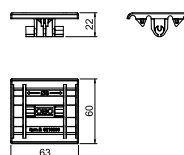

Ramming pile, free-standing system

St FT

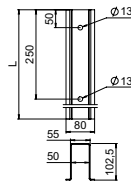

Type	Length mm	Pack Piece	Item no.
RP 1800 FT	1800	1	5900106
RP 2300 FT	2300	1	5900110

Ramming pile as a bracket for pre-mounted supports to mount free-standing photovoltaic systems. Mounting in the earth through ramming.

Stand, free-standing system

St FT

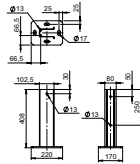

Type	Pack Piece	Item no.
SF 400 FT	1	5900900

Stand as a bracket for pre-mounted supports to mount free-standing PV systems. Mounting on concrete foundations with M16 bolt ties. Fastening material must be ordered separately.

Pre-mounted supports for PV module mounting, free-standing system

St FT

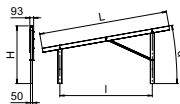

Type	Angle α °	Dim. H mm	Dim. L mm	Dim. I mm	Module height mm	Pack Piece	Item no.
VT 10S FT	10	1376	2705	2265	1600-1850	1	5901550
VT 10M FT	10	1413	3119	2265	1850-2100	1	5901552
VT 10L FT	10	1445	3488	2265	2100-2400	1	5901554
VT 25S FT	25	1996	2516	2085	1600-1850	1	5901556
VT 25M FT	25	2085	2896	2085	1850-2100	1	5901558
VT 25L FT	25	2164	3236	2085	2100-2400	1	5901560
VT 30S FT	30	2188	2413	1992	1600-1850	1	5901562
VT 30M FT	30	2293	2777	1992	1850-2100	1	5901564
VT 30L FT	30	2387	3102	1992	2100-2400	1	5901566

Pre-mounted support in small, medium or large size to mount free-standing photovoltaic systems in combination with support profiles and end/connection clamps. Mounting with ramming piles in the earth or with stands on concrete foundations.

St FT

Support profile for PV module mounting, free-standing system

Type	Length mm	Module width mm	Pack Piece	Item no.
TP 1000 FT	5650	990-1000	1	5900500
TP 1010 FT	5705	1000-1010	1	5900502
TP 1020 FT	5760	1010-1020	1	5900504
TP 1030 FT	5815	1020-1030	1	5900506
TP 1040 FT	5780	1030-1040	1	5900508
TP 1050 FT	5925	1040-1050	1	5900510
TP 1060 FT	5980	1050-1060	1	5900512
TP 1100 FT	5090	1090-1100	1	5900520
TP 1140 FT	5270	1130-1140	1	5900522
TP 1310 FT	6035	1300-1310	1	5900530

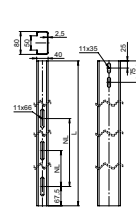

Support profile to mount photovoltaic modules on free-standing systems. Mounting of support profile on pre-mounted supports with KV FT cross-connectors. Mounting of the PV modules on the support profile with end and/or connection clamps. Connection of multiple support profiles with LV FT straight connectors and KV FT cross-connectors, screw-on.

St FT

CE

Straight connector for support profiles, free-standing system

Type	Pack Piece	Item no.
LV FT	20	5901215

Straight connector to connect support profiles for free-standing photovoltaic systems. Fastening with pre-installed M6 screw, screw-on with Torx 30 wrench.

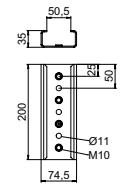

St FT

CE

Cross-connector for TP support profiles, free-standing system

Type	Pack Piece	Item no.
KV FT	50	5901255

Cross-connector to connect support profiles for free-standing photovoltaic systems. Fastening with pre-installed M8 screw, screw-on with Torx 40 wrench.

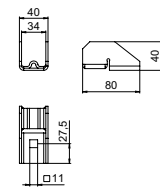

A4 2B

CE

Hook-head screw

Type	Pack Piece	Item no.
MS50HB M12x30 A4	50	1148276
MS50HB M12x60 A4	25	1148280

Hook-head screw for use with MS5030 profile rail

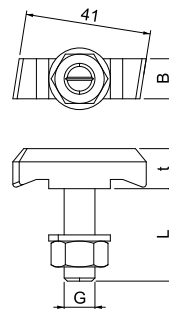

End clamp for PV module mounting, free-standing system

A2

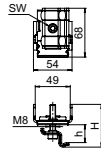

Type	For frame height mm	Pack Piece	Item no.
KLE 20 A2	20	50	5901070
KLE 25 A2	25	50	5901072
KLE 30 A2	30	50	5901074
KLE 35 A2	35	50	5901076
KLE 40 A2	40	50	5901078
KLE 45 A2	45	50	5901080
KLE 50 A2	50	50	5901082

End clamp for fastening photovoltaic modules on support profiles of free-standing systems. Lockable pre-fastening of the module frames on the support profile. Suitable for slot width 10 mm. Lockable fastening of the PV module with Torx 30 wrench.

Connection clamp for PV module mounting, free-standing system

A2

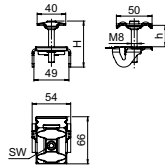
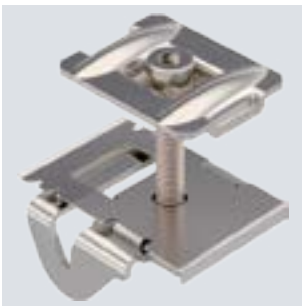

Type	For frame height mm	Pack Piece	Item no.
KLZ 2030 A2	20-30	50	5901050
KLZ 3040 A2	30-40	50	5901054
KLZ 4050 A2	40-50	50	5901058

Connection clamp for fastening photovoltaic modules on support profiles of free-standing systems. Lockable pre-fastening of the module frames on the support profile. Suitable for slot width 10 mm. Lockable fastening of the PV module with Torx 30 wrench.

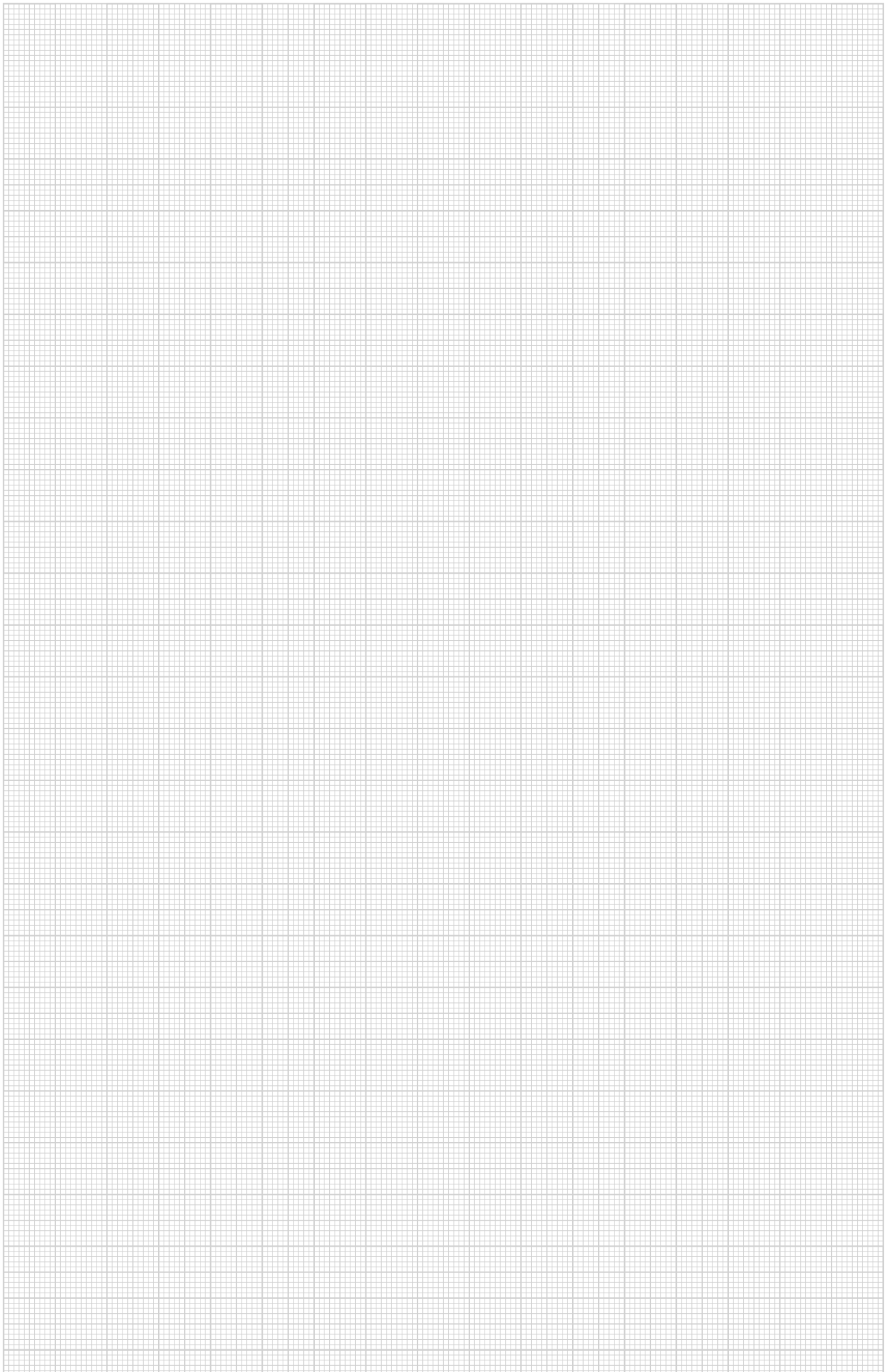

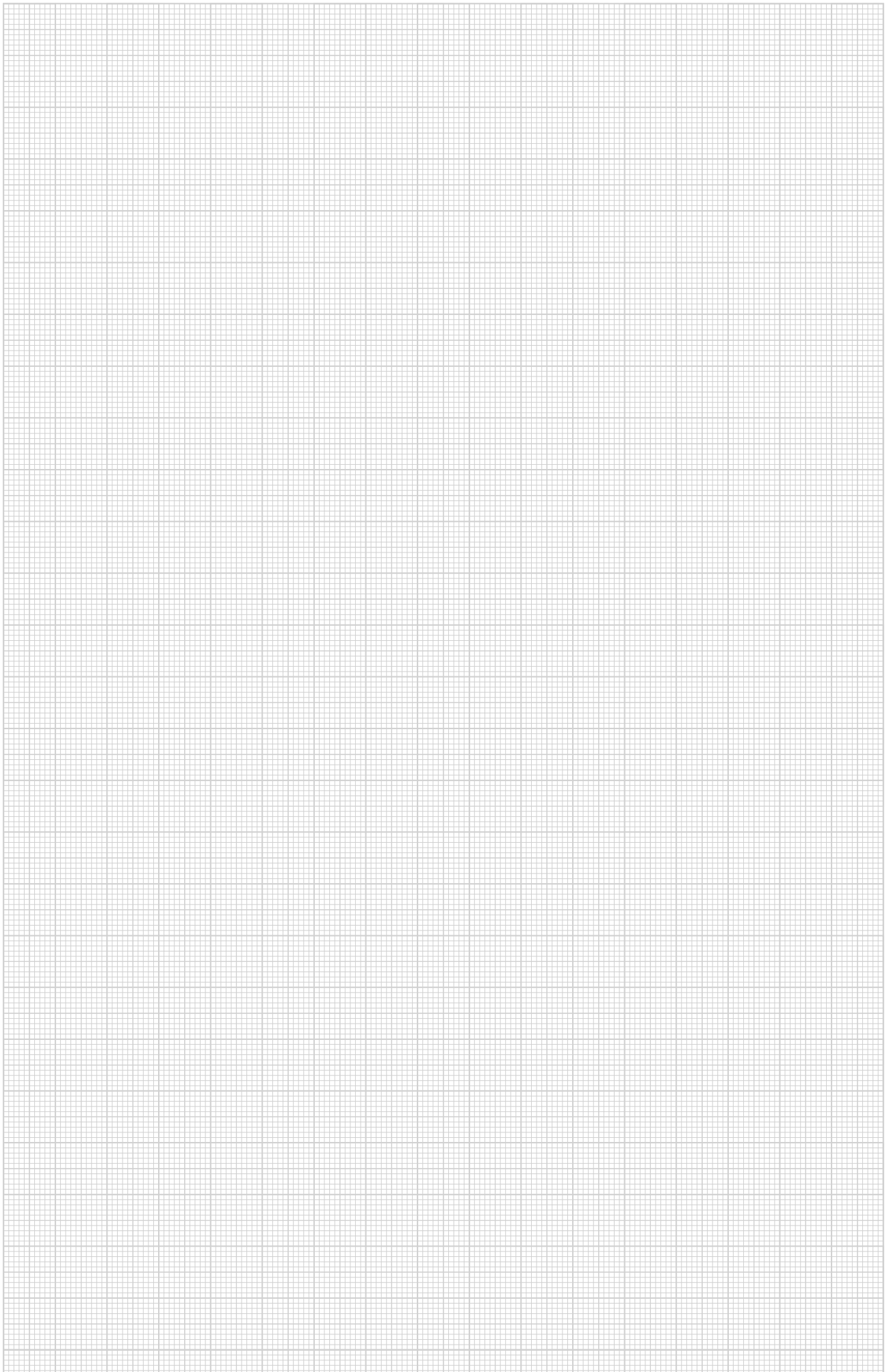

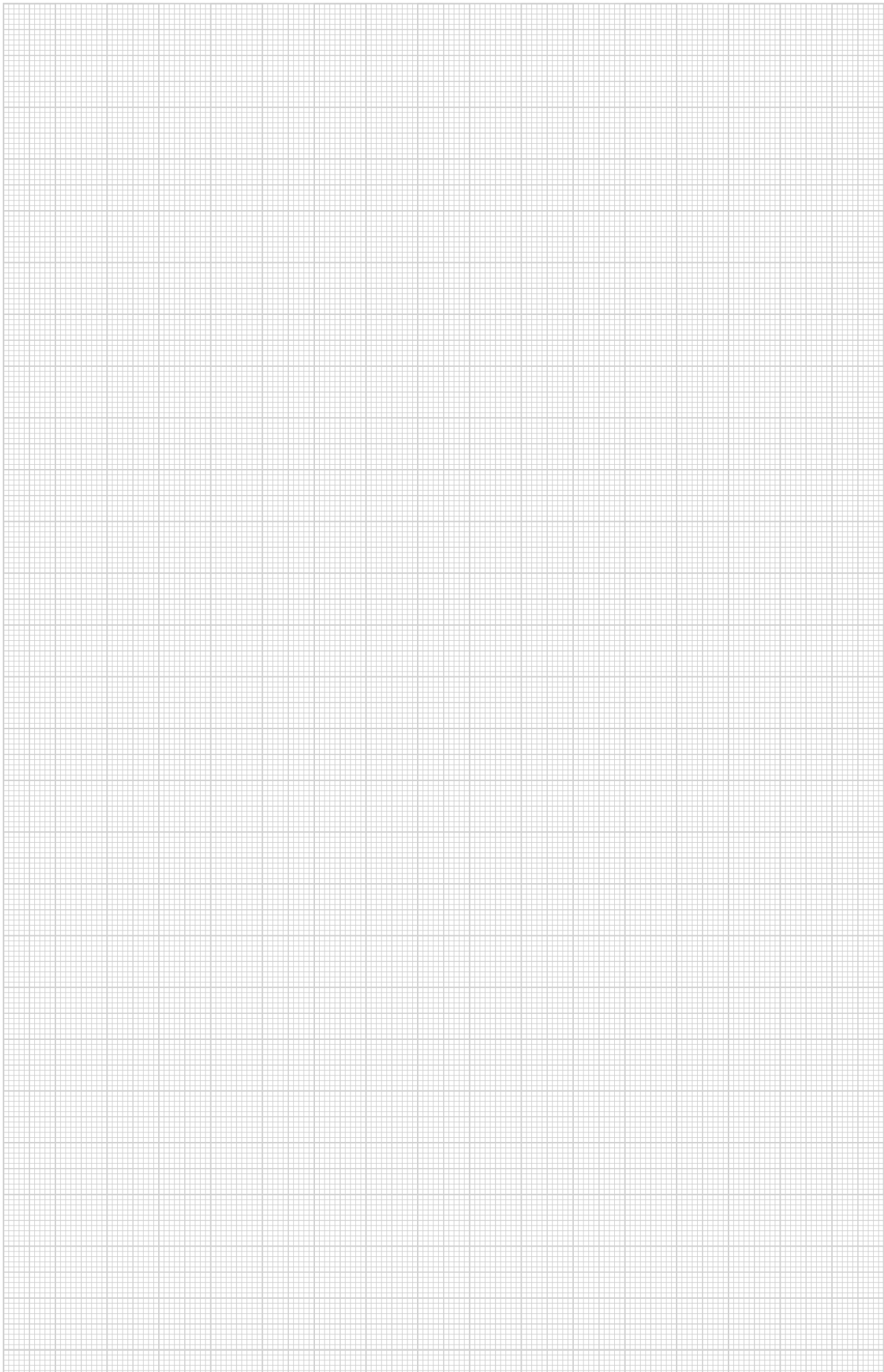

You can find additional information on the OBO Magic PV Solution mounting systems at obo.eu/photovoltaics

OBO Bettermann Holding GmbH & Co. KG

P.O. Box 1120
58694 Menden
GERMANY

Customer Service

Tel.: +49 23 73 89 - 17 00
export@obo.de

www.obo-bettermann.com

© OBO Bettermann Order No. 9177993 04/2024 EN